

Storage unit

140 Litres



Instruction manual

General Information

1. Unpack the unit carefully, paying special attention to any damage that it may have suffered and checking that the contents of the package matches what is indicated on the delivery note. Inform the distributor immediately of any damage and any non-conformity with what is indicated.
2. Read these instructions carefully before starting the unit.
3. This instruction manual must be kept available to users of this unit.
4. With any queries regarding installation, servicing or maintenance, contact:

TECNOVET, S.L.
Ronda de la Font Grossa nº 22
P.I. La Gavarra
08540 Centelles – Barcelona, Spain
Tel: +34 938 813 898
Website: www.import-vet.com
e-mail: int@import-vet.com

Technical features

Reference: 10.114.01
Capacity: 140 litres
Temperature range: 5 to 55 °C
Stability: +/-1 °C
Resolution: 0.1 °C
Outer measurements: 850 x 595 x 635 mm
Weight: 37.08 Kg
Consumption: 70 W
Temperature and relative
operating humidity: 5 to 32 °C 80% RH
Temperature control: Electronic - digital

Important:

1. The appliance is only unpowered when it has been disconnected from the mains. Always unplug the appliance before cleaning or maintenance.
2. Do not use pointed or sharp objects when cleaning, as this could seriously damage your appliance.
3. Be careful not to pour liquids onto the ventilation unit or the temperature controller.
4. Do not place hot containers touching the plastic parts inside the appliance.
5. Do not store gas or flammable liquids inside the appliance, as this could cause an explosion.
6. Place the appliance against the wall to avoid
7. reaching or touching its hot parts, such as the compressor or the condenser.
8. When moving the appliance, check that it is not plugged in.
9. Before connecting the appliance to the mains, check that its voltage matches what is indicated on the nameplate. This equipment is supplied with a
10. EURO-type plug (DIN49441). Where the plug must be changed, follow the colour code below.

Blue wire: Neutral

Brown wire: Live

Yellow-green wire: Earth

Installation

Transportation and unpacking

The appliance must not be plugged into the mains for around two hours after it has been transported.

Unpack the appliance and check it for damage. Immediately inform of any defects. In this case, do not dispose of the packaging.

Cleaning

Remove all the adhesive tapes securing the internal parts of the appliance. Clean the inside of the appliance using warm water and a mild detergent. Be careful not to pour liquid onto the ventilation unit. Use a soft cloth.

Dry the surface once the appliance has been cleaned.

Location

The room temperature might affect the correct working order of the appliance and its energy consumption. When choosing the location, remember that it should operate within the temperature and relative humidity limits specified.

Do not place the appliance in a very sunny place or next to a source of heat. Position the equipment horizontally and levelled. When positioning the unit, make sure the recommended minimum distances are kept, as shown in Figure 1.

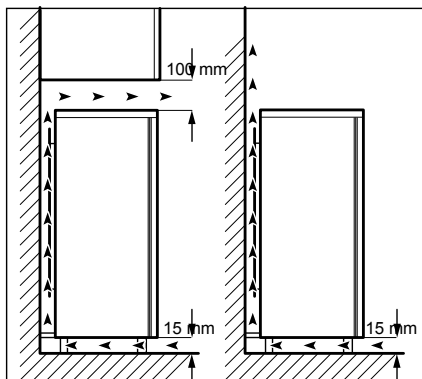

Figure 1

Changing door opening direction

WARNING! Always unplug the appliance before performing any operation.

CAUTION! The procedures indicated below require the assistance of another person to hold onto the doors of the appliance throughout the process.

1. Loosen the two screws at the rear (1).
2. Push the top part back and lift (2).
3. Unscrew the left foot.
4. Loosen the screws on the lower door hinge. Remove the hinge. Place the pin in the direction indicated by the arrow (3).
5. Unscrew and then install the screw on the other side.
6. Install the hinge on the other side.
7. Screw in the right foot.
8. Loosen the screws on the upper door hinge (4).
9. Remove the hinge. Place the pin in the direction indicated by the arrow. Install the hinge on the other side (5).
10. Tighten the hinge.
11. Place the top part in position.
12. Push the top part forwards.
13. Tighten the two screws at the rear.
14. Remove and install the handle on the other side (6).

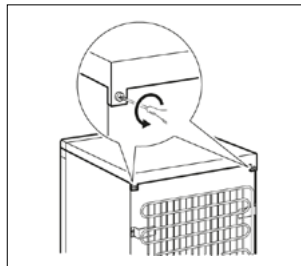

Figure 1

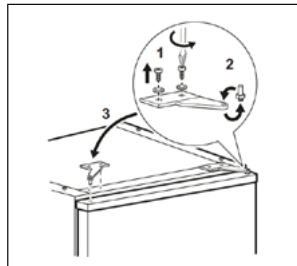

Figure 4

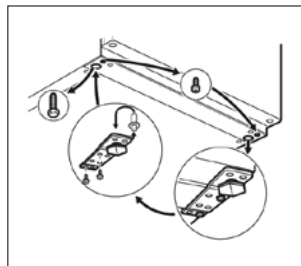

Figure 2

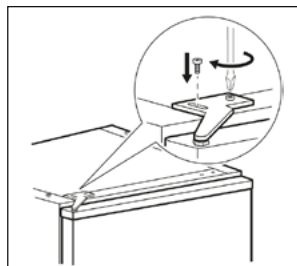

Figure 5

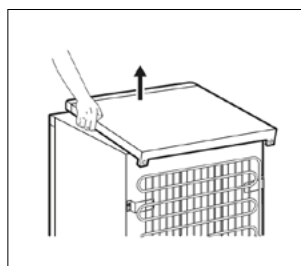

Figure 3

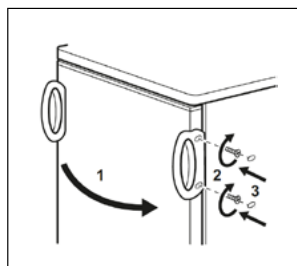

Figure 6

Start-up

Temperature setting

Press and release the **ENTER** key. The screen will show the value SP flashing red and the value currently set will be displayed green.

To change it, press the increase key or the decrease key to increase or decrease the set temperature value and confirm by pressing the **PISANI** key once or not pressing anything for 10s.

These keys allow for a one-digit number change, but the value will increase or decrease more quickly if they are kept pressed down for two seconds.

Programming mode is exited automatically by not pressing any key for around 10s.

IMPORTANT!!!

Do not keep the ENTER key pressed down for more than five seconds, as this would take you to the settings menu. This could lead to appliance malfunctioning.

The compressor will start up one minutes after it has been connected to the mains.

Maintenance

Cleaning

1. The inside of the storage unit should be cleaned every three or four weeks.
2. After unplugging the appliance, clean the inside with warm water and then dry the surface. Do not dampen the fan-resistor unit.
3. Clean the magnetic door seal with clean water.
4. Clean any accumulated dust and dirt from the fridge condenser located at the rear of the appliance at least once or twice a year.
5. Plug the appliance back into the mains after cleaning.

Environment

The appliance contains no gases that could damage the ozone layer in either its refrigeration circuit or in the insulation materials.

Avoid damaging the refrigeration circuit located at the rear of the appliance.

Warranty

- Two-year warranty against all operating defects due to manufacturing or materials.
- The warranty does not cover accidents due to the misuse or incorrect care of the appliance.
- The warranty does not cover faults or imperfections caused by undue use or transport, or if the appliance has not been connected to a socket with a good earthing device.
- The warranty is also rendered null and void if the appliance has been handled by personnel not duly authorised to do so.

Declaration of conformity

The company:

TECNOVET, S.L.
Ronda de la Font Grossa nº 22
P.I. La Gavarra
08540 Centelles
Barcelona, Spain

Phone: +34 938 813 898
Website: www.import-vet.com
int@import-vet.com



Declares under its
sole responsibility
that the product:

Storage Unit 140 Litres
Ref: 10.114.01

**Is in compliance with the following
European directives:**

73/23/CE Low Voltage Directive
89/336/CE Electromagnetic
Compatibility Directive

Name:
Position:

Place and date:

Signature:

